

Blow Gun

RoHS

New

20% reduction in power consumption

with the SMC "Blow gun" + "S coupler" + "Coil tube"

*10% reduction with the "Blow gun (VMG)" only

New

With cover



Extension nozzle

Added 100 mm and 150 mm lengths

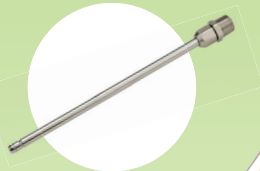

Pressure loss **1% or less**

Amount of electricity used in a factory

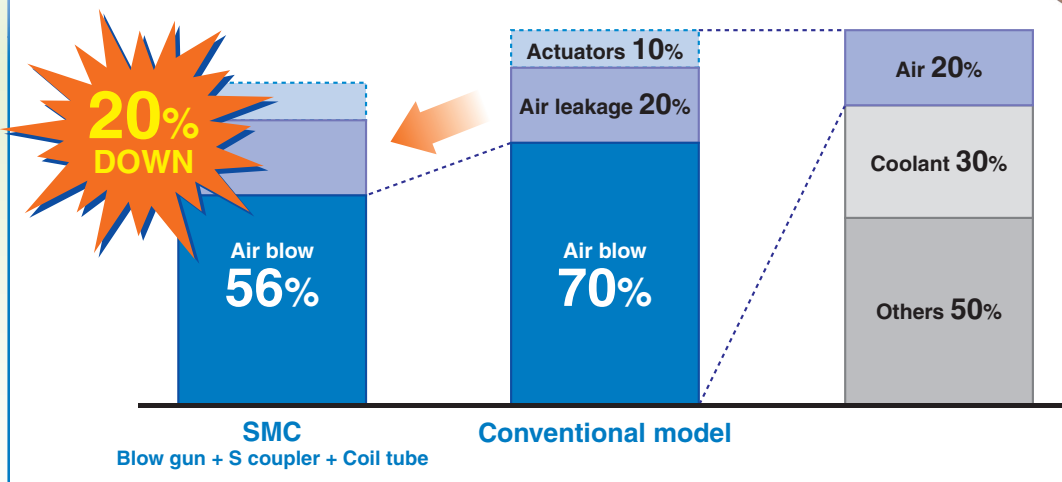

The electricity used by compressors for air accounts for **approximately 20%** of that consumed by the entire factory. Also, **70%** of the air consumed in the process is used for air blowing. SMC blow guns have minimal pressure loss compared with conventional models, so they can achieve equivalent performance at lower pressures and with less volume of air consumption. As a result, it is possible to achieve a **20% reduction** in power consumption.

Series VMG



CAT.EUS50-20F-UK

Energy Saving Pneumatic System Proposal

Energy Saving Effects

When the yearly total working hours spent on air blowing amounts to 8,300 hours, the use of conventional models results in power consumption costs totaling 1540,95 €. When using the SMC system (Blow gun + S coupler + Coil tube), however, the yearly cost is reduced to 1235 €, for a **total yearly saving of 306 €, or 20% of the total.**

Energy saving effects with **Blow gun (VMG) + S coupler + Coil tube**

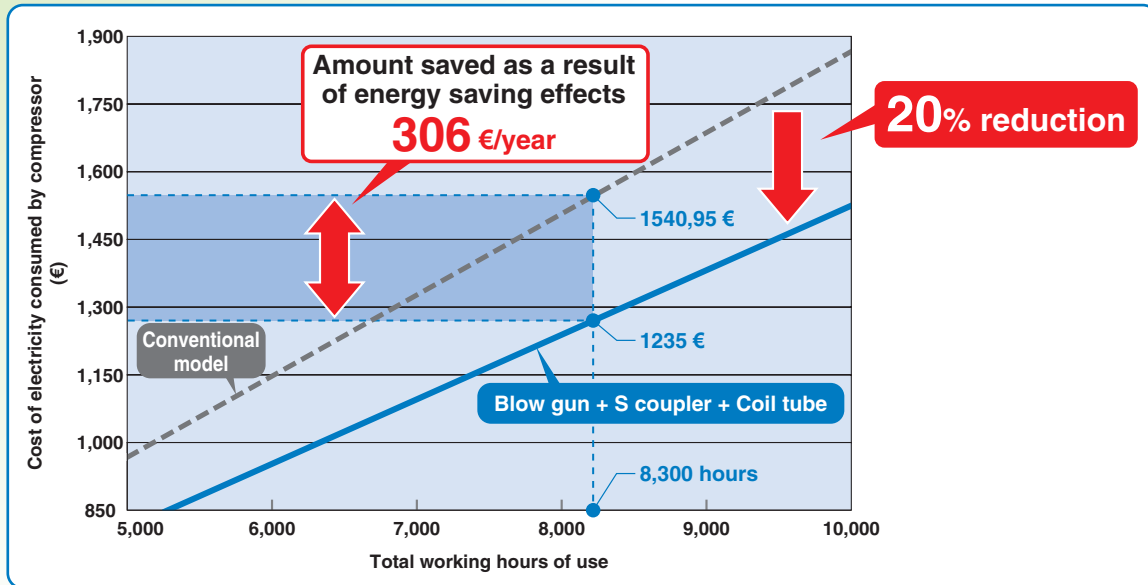

Energy saving effects with **Blow gun (VMG) only**

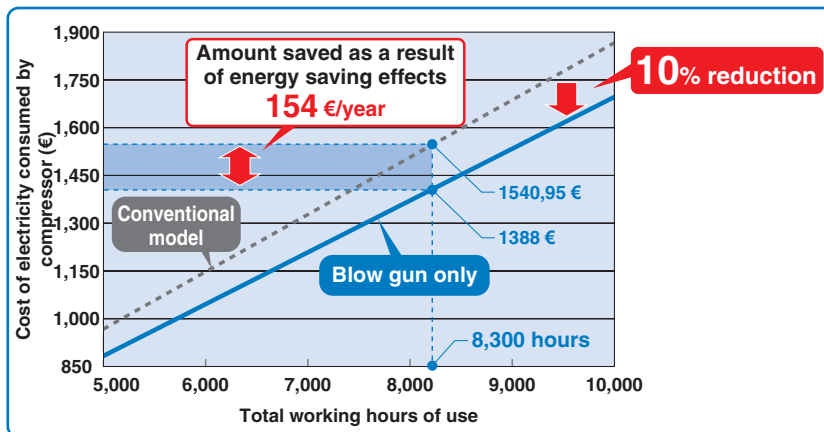

Calculation conditions

- Blowing distance: 100 mm
- Impact pressure: 0.011 MPa
- Cost of electricity: 0,12 €/kWh

Work model

- Blow time: 10 seconds
- Frequency: 12 times/hour
- Working hours: 10 hours/day
- Working days: 250 days/year
- Units used: 100
- Resulting total working hours: 8,300 hours

Valve Construction and Pressure Loss

Straighter flowing fluid
"improves pressure loss!"

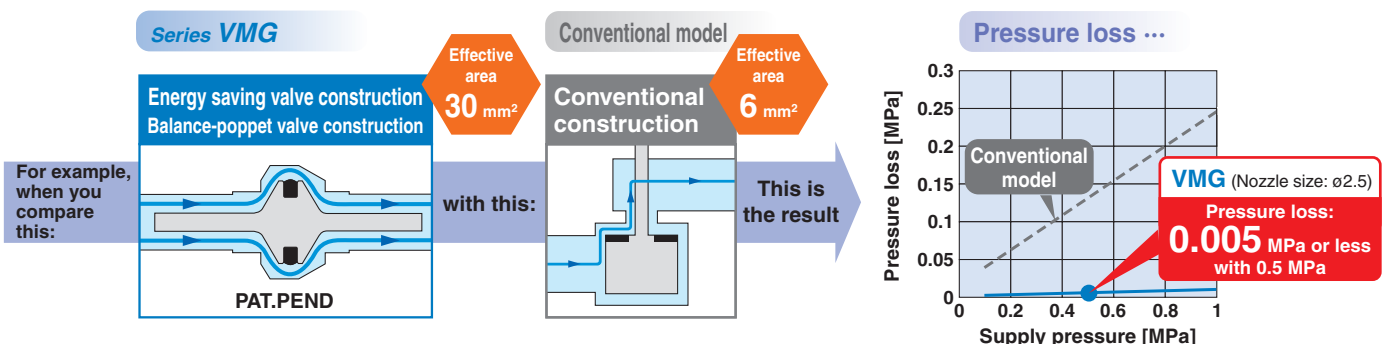

SMC helps you work toward a revolutionized production system with a focus on saving-energy.



Example of Improvement

Review the air-blow job and change to the SMC blow gun, S coupler and coil tube to create a larger effective area.

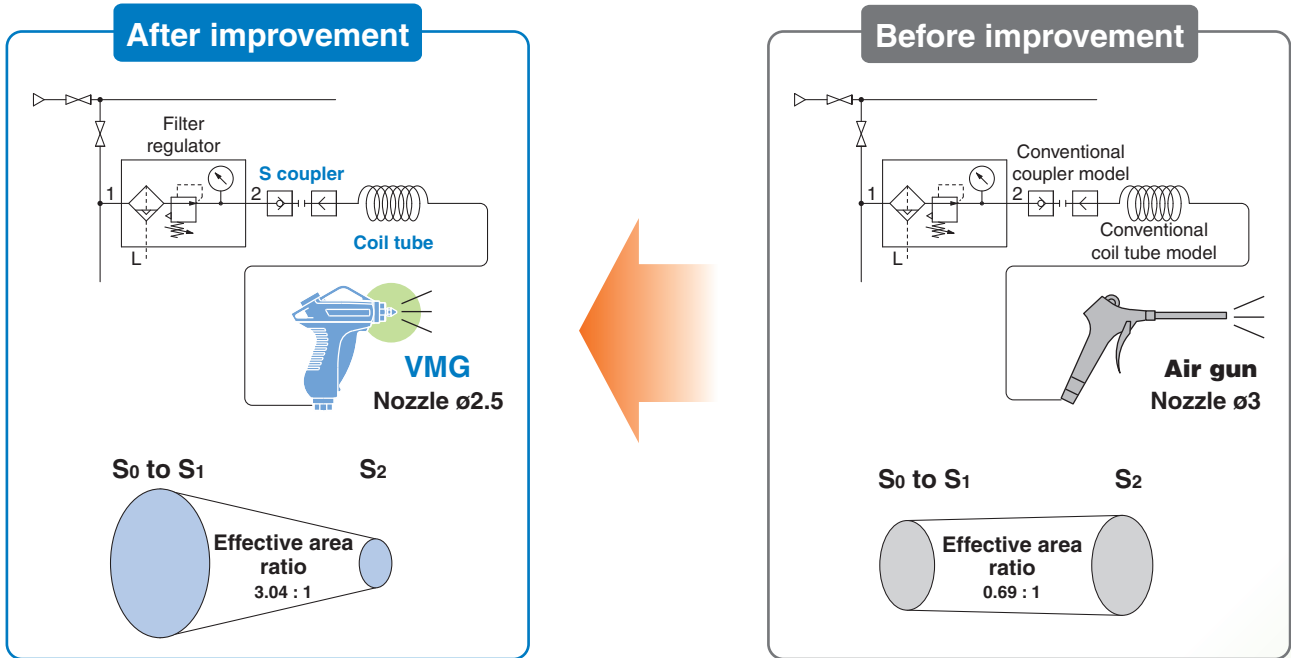

		After improvement	Before improvement
Equipment	Coupler	S coupler	Conventional model
	Piping	TCU1065-1-20-X6	Conventional coil tube model (I.D. $\phi 5$, equivalent length 5 m)
	Air gun	VMG (Nozzle size $\phi 2.5$)	Conventional model (Nozzle size $\phi 3$)
Effective area	Coupler, Piping (S ₀)	13.45 mm ²	5.1 mm ²
	Air gun (S ₁)	30 mm ²	6 mm ²
	Nozzle (S ₂)	4.4 mm ²	6.3 mm ²
Effective area ratio (S ₀ to S ₁ : S ₂)		3.04 : 1	0.69 : 1
Impact pressure		0.011 MPa (at a distance of 100 mm)	0.011 MPa (at a distance of 100 mm)
Regulator pressure		0.4 MPa	0.5 MPa
Pressure inside nozzle		0.385 MPa	0.276 MPa
Compressor pressure		0.5 MPa	0.6 MPa
Air consumption		257 dm³/min (ANR)	287 dm³/min (ANR)
Power consumption by compressor		1.25 kW	1.56 kW

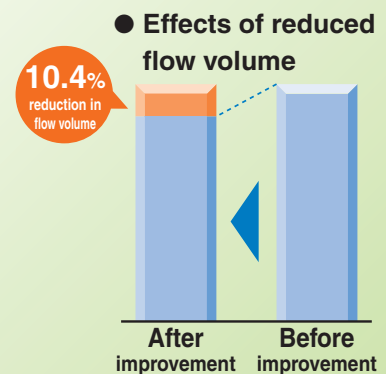
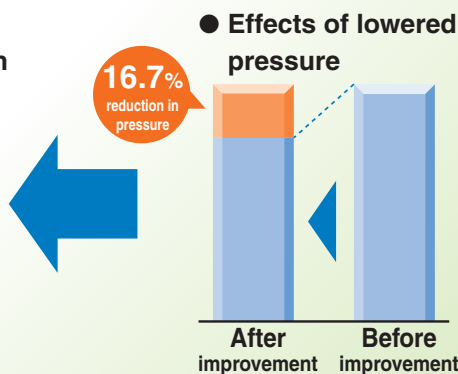
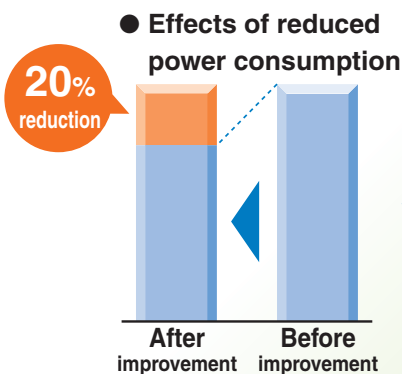

Blow Gun, Coil Tube and S Coupler Selection

Recommended system in accordance with the distance

Energy saving effects are enhanced through the appropriate blow gun model selection in accordance with the distance from the target object.

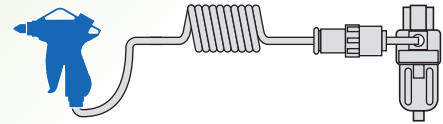

Distance	Recommended system				
	Blow gun	Nozzle size	Fitting	Coil tube*	S coupler
Up to 20 mm	VMG1□□-02-01	ø1	KQ2H06-02AS	TCU0604□-1-20-X6	KK4P-06H
Up to 40 mm	VMG1□□-02-02	ø1.5	KQ2H06-02AS	TCU0604□-1-20-X6	KK4P-06H
Up to 60 mm	VMG1□□-02-03	ø2	KQ2H08-02AS	TCU0805□-1-20-X6	KK4P-08H
Over 60 mm	VMG1□□-02-04	ø2.5	KQ2H10-02AS	TCU1065□-1-20-X6	KK4P-10H

Energy Saving Flow

Air guns with an effective area around 6 mm² are most commonly used. But the SMC blow gun achieves a 30 mm² effective area.

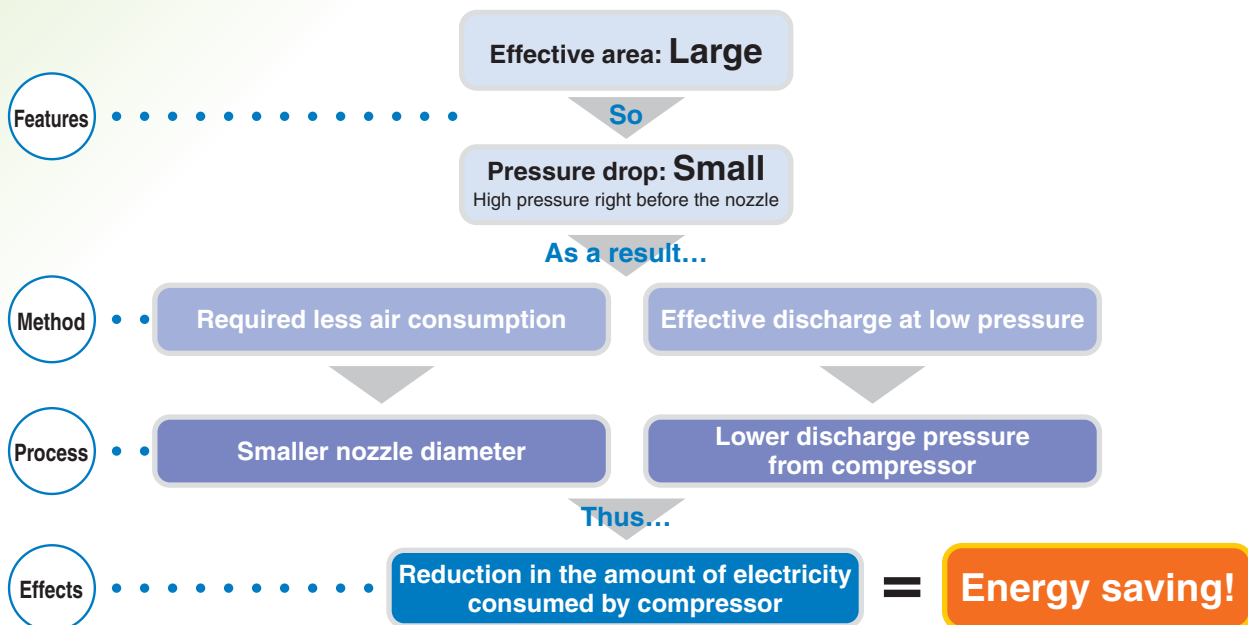

Related Product

For pressure loss improvement **S coupler: Series KK**

Improved fitting's restrictor and leakage



■ Special method of connection and fixation

With a structure that employs no steel balls, the coupler achieves a slim body without narrowing of the channel, allowing coverage of a wide effective area.

■ Smooth channel with minimal unevenness

By not blocking the channel with the valve spring, the loss of effective area can be minimised.

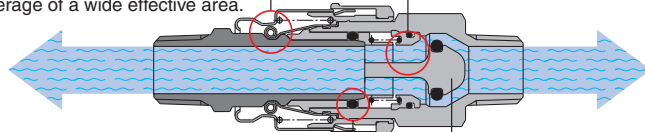

■ Seal structure with minimal leakage

The surface-to-surface flow design allows super-tight sealing.

■ Conical structure of check valve tip

This structure achieves smooth flow through the channel.

Variations

Nozzle type

Low noise nozzle

Mono-porous nozzle ($\phi 2$) 90 to 100 dB
 $\phi 1 \times 4$ low noise nozzles 80 dB or less
 Note) Supply pressure: 0.5 MPa
 Measured at a 45 degree angle according to JIS B 8379



* Achieving lower noise by dividing the air blow slit

Male thread nozzle

Nozzle size: $\phi 1, \phi 1.5, \phi 2, \phi 2.5, \phi 3, \phi 3.5, \phi 4$



* Powerful and economical

High efficiency nozzle



* Makes use of the Bernoulli effect to amplify the air blow flow rate

Copper extension nozzle

Nozzle length: 100 mm, 150 mm, 300 mm, 600 mm



* Secures more power even at a greater distance from a workpiece.



One-touch fitting type



With cover

Cover for male thread nozzle



Cover for copper extension nozzle (Outside diameter $\phi 6$ only)



Bottom <Dark blue>

S coupler plug type

Top <White>

Connection type

Screw-in type

Port size

Rc, NPT, G 1/4
Rc, NPT, G 3/8

S coupler plug type

Plug part no.

KK4P-02MS
KK130P-02MS

One-touch fitting type

Applicable tube O.D.

Metric size: $\phi 6, \phi 8, \phi 10$
Inch size: $\phi 1/4", \phi 5/16", \phi 3/8"$

Operability, Safety, Environment

Not affected by supply pressure, assured operability



When using this product even at a high pressure, the same gripping force is required as for a lower pressure due to the unique balance-poppet construction.

Use of shock-resistant resin

Shock-resistant resin is used in the main body. No cracks, breaks or other damage occurred in a drop test from a 2-meter height or in a human stomp test.

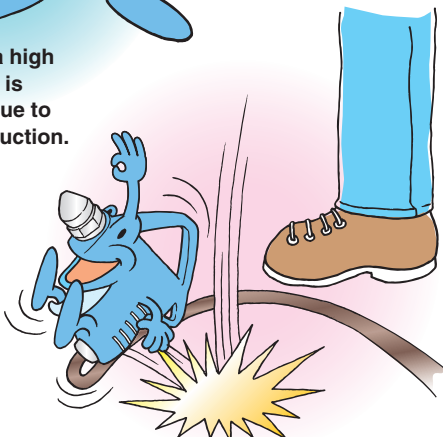

Components are separable. Environmentally friendly

Resin parts are inscribed with the name of the material. Additionally, all parts can be separated by material.

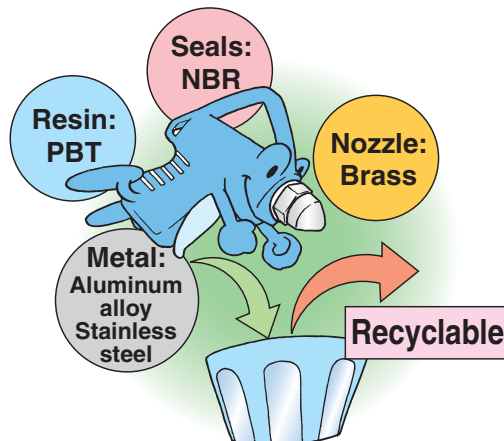

Blow Gun Series VMG

RoHS



How to Order

VMG 1 1 W - 02 - 32 - C

Piping entry

1	Bottom
2	Top

Body color

W	White
BU	Dark blue

Connection size

Symbol	Piping connection method	Size and model no.	
02	Threaded	Thread size	Rc1/4
03			Rc3/8
N02			NPT1/4
N03			NPT3/8
F02			G1/4
F03			G3/8
11			S coupler plug
12	Metric size one-touch fitting	Model no. of fitting used	KK130P-02MS
H06		KQ2H06-02AS	
H08		KQ2H08-02AS	
H10		KQ2H10-02AS	
H07	Inch size one-touch fitting	Model no. of fitting used	KQ2H07-35AS
H09		KQ2H09-35AS	
H11		KQ2H11-35AS	

Note 1) S coupler and fitting are included in the same package.

Note 2) Port size is Rc1/4 if using the S coupler plug.

Note 3) The blow gun port size is Rc1/4 if using the metric size one-touch fitting.

Note 4) The blow gun port size is NPT1/4 if using the inch size one-touch fitting.

With nozzle cover (Only for male thread nozzle, ø6 extension nozzle)

—	None
C	With nozzle cover/HNBR
CF	With nozzle cover/Fluororubber

Nozzle

Symbol	Type	Nozzle size	Nozzle part no.
—	Without nozzle		
01	Male thread nozzle	ø1	KN-R02-100
02		ø1.5	KN-R02-150
03		ø2	KN-R02-200
04		ø2.5	KN-R02-250
05		ø3	VMG1-R02-300
06		ø3.5	VMG1-R02-350
07		ø4	VMG1-R02-400
11	High efficiency nozzle	ø1	KNH-R02-100
12		ø1.5	KNH-R02-150
13		ø2	KNH-R02-200
21	Low noise nozzle with male thread	ø0.75 x 4	KNS-R02-075-4
22		ø0.9 x 8	KNS-R02-090-8
23		ø1 x 4	KNS-R02-100-4
24		ø1.1 x 8	KNS-R02-110-8

Extension nozzle

Symbol	Type	Nozzle length	Nozzle size	Nozzle part no.
31	ø6 copper extension nozzle (Note)	300 mm	ø1.5	VMG1-06-150-300
32			ø2	VMG1-06-200-300
33			ø1.5	VMG1-06-150-600
34		100 mm	ø2	VMG1-06-200-600
35			ø1.5	VMG1-06-150-100
36			ø2	VMG1-06-200-100
37	150 mm	ø1.5	VMG1-06-150-150	
38		ø2	VMG1-06-200-150	
41	ø8 copper extension nozzle (Note)	100 mm	ø2.5	VMG1-08-250-100
42			ø3	VMG1-08-300-100
43			ø3.5	VMG1-08-350-100
44		150 mm	ø2.5	VMG1-08-250-150
45			ø3	VMG1-08-300-150
46			ø3.5	VMG1-08-350-150
47		300 mm	ø2.5	VMG1-08-250-300
48			ø3	VMG1-08-300-300
49			ø3.5	VMG1-08-350-300
50			ø2.5	VMG1-08-250-600
51	600 mm	ø3	VMG1-08-300-600	
52		ø3.5	VMG1-08-350-600	

Note) Part number for set of extension nozzle and fitting. Extension nozzle and fitting are included in the same package.

Refer to "How to attach extension nozzle" in the operation manual for assembly procedures.

Specifications

Fluid	Air	
Operating pressure range	0 to 1.0 MPa	
Proof pressure	1.5 MPa	
Ambient and fluid temperature	-5 to 60°C (No freezing)	
Flow-rate characteristics (With nozzle removed)	C (dm ³ /s-bar): 6.0, b: 0.25 (Effective area: 30 mm ²)	
Port size	Rc, NPT, G 1/4, 3/8	
Piping entry	Bottom	Top
Nozzle port size	Rc1/4	
Weight (Main unit only)	165 g	
Operational force (when the valve is fully open)	7 N	

Construction

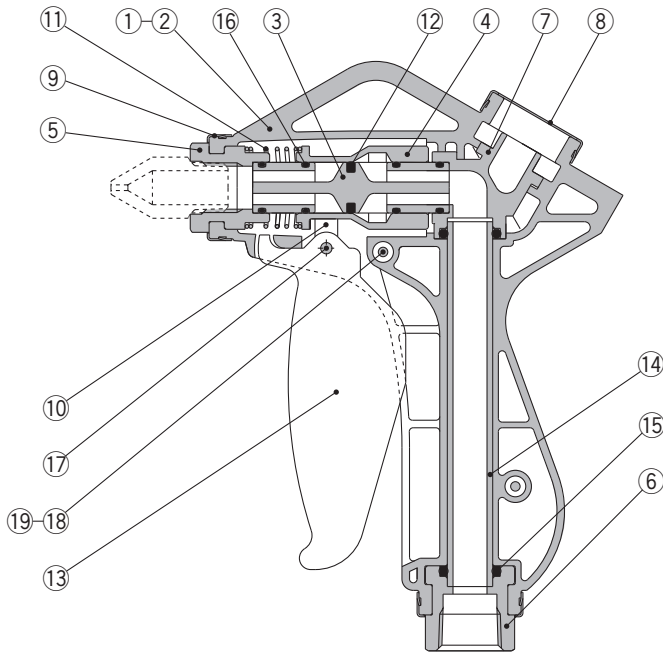

Component Parts

No.	Description	Material	Note
1	Body L	PBT	
2	Body R	PBT	
3	Main valve	PBT	
4	Valve guide	POM	
5	Nozzle holder	Aluminium alloy	Anodized
6	Port	Aluminium alloy	Anodized
7	Elbow	PBT	Only for the VMG12□
8	Cover	Stainless steel	
9	Ring	Stainless steel	
10	Arm	PBT	
11	Spring	Stainless steel	
12	Main valve seal	HNBR	
13	Lever	PBT	
14	Piping (bottom)	POM	Only for the VMG11□ Combined with the elbow (7).
15	O-ring	NBR	
16	O-ring	NBR	
17	Parallel pin	Stainless steel	
18	Cross recessed round head screw	Stainless steel	
19	Hexagon nut	Stainless steel	

Note) Grease is used on rubber and sliding sections.

Flow-rate Characteristics

Note) Values when the main valve is fully open

Male thread nozzle

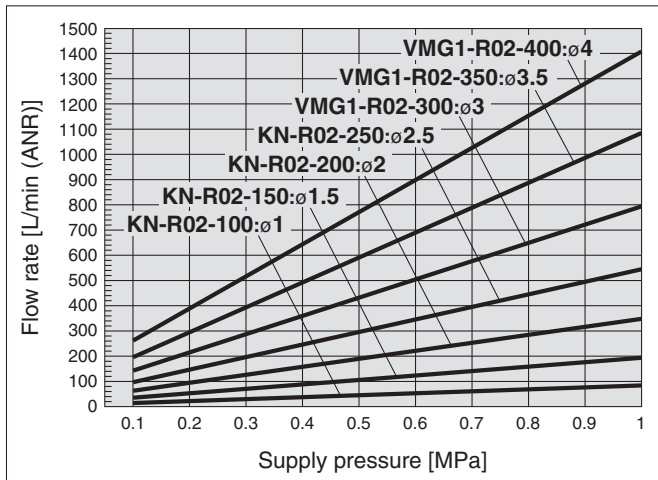

High efficiency nozzle

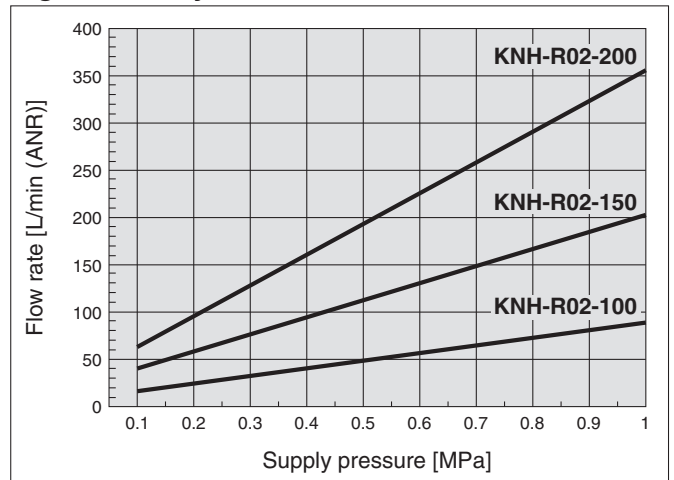

Low noise nozzle with male thread

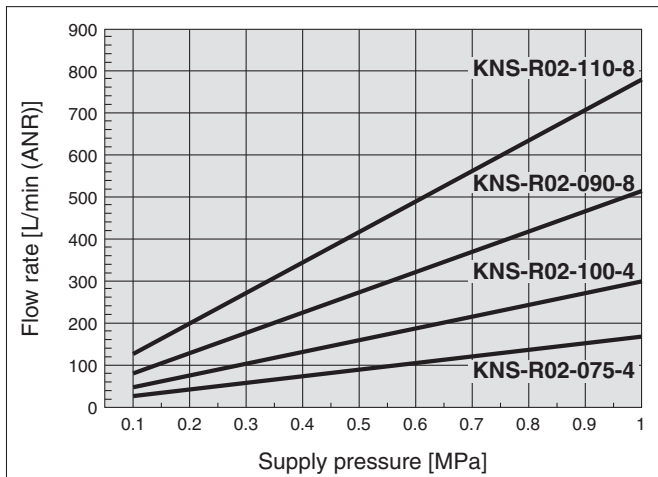

Copper extension nozzle

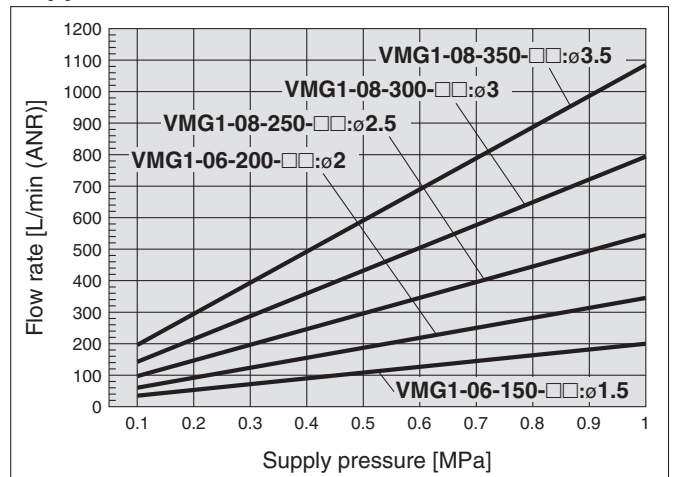

Series VMG

Dimensions

VMG11/Piping entry: Bottom

Note) Reference dimensions after installation

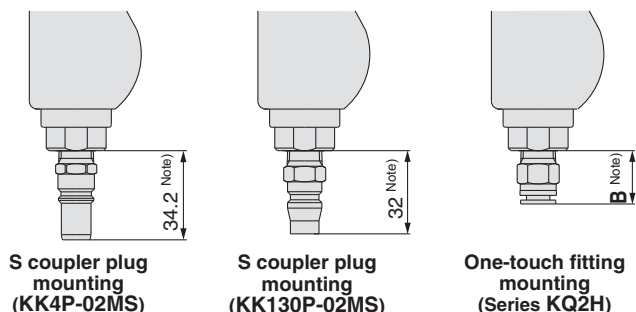
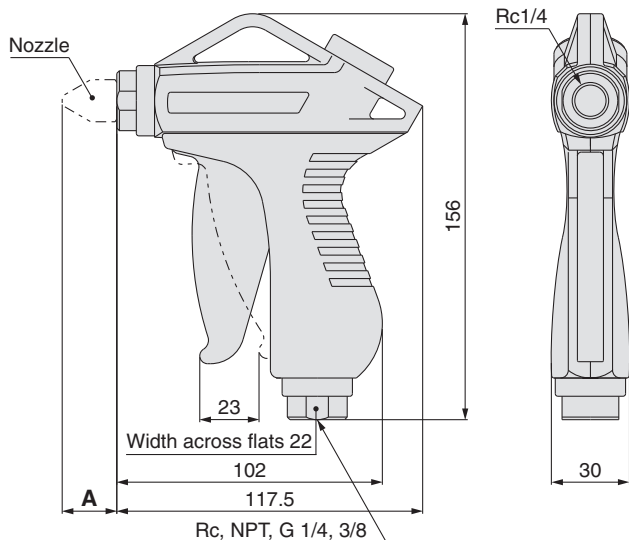

VMG12/Piping entry: Top

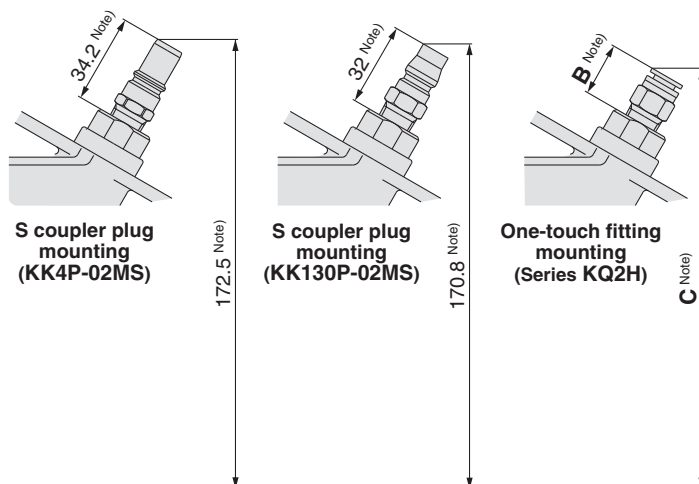
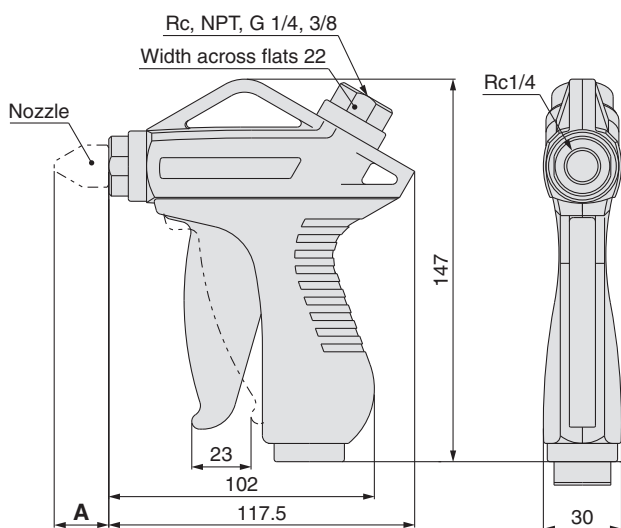

Symbol	Type	Nozzle part no.	Nozzle size	A ^{Note)}	
01	Male thread nozzle	KN-R02-100	ø1	23.4	
02		KN-R02-150	ø1.5	23	
03		KN-R02-200	ø2	22.5	
04		KN-R02-250	ø2.5	22.1	
05		VMG1-R02-300	ø3	22	
06		VMG1-R02-350	ø3.5	21.5	
07		VMG1-R02-400	ø4	21.5	
11	High efficiency nozzle	KNH-R02-100	ø1	44	
12		KNH-R02-150	ø1.5		
13		KNH-R02-200	ø2		
21	Low noise nozzle with male thread	KNS-R02-075-4	ø0.75 x 4	12	
22		KNS-R02-090-8	ø0.9 x 8		
23		KNS-R02-100-4	ø1 x 4		
24		KNS-R02-110-8	ø1.1 x 8		
31	ø6 copper extension nozzle ^{Note)}	Nozzle length: 300 mm	VMG1-06-150-300	ø1.5	298
32		Nozzle length: 300 mm	VMG1-06-200-300	ø2	
33		Nozzle length: 600 mm	VMG1-06-150-600	ø1.5	598
34		Nozzle length: 600 mm	VMG1-06-200-600	ø2	
35		Nozzle length: 100 mm	VMG1-06-150-100	ø1.5	98
36		Nozzle length: 100 mm	VMG1-06-200-100	ø2	
37		Nozzle length: 150 mm	VMG1-06-150-150	ø1.5	148
38		Nozzle length: 150 mm	VMG1-06-200-150	ø2	

Note) Reference dimensions after installation

Symbol	Type	Nozzle part no.	Nozzle size	A ^{Note)}
41	Nozzle length: 100 mm	VMG1-08-250-100	ø2.5	98
42		VMG1-08-300-100	ø3	
43		VMG1-08-350-100	ø3.5	
44	Nozzle length: 150 mm	VMG1-08-250-150	ø2.5	148
45		VMG1-08-300-150	ø3	
46		VMG1-08-350-150	ø3.5	
47	Nozzle length: 300 mm	VMG1-08-250-300	ø2.5	298
48		VMG1-08-300-300	ø3	
49		VMG1-08-350-300	ø3.5	
50	Nozzle length: 600 mm	VMG1-08-250-600	ø2.5	598
51		VMG1-08-300-600	ø3	
52		VMG1-08-350-600	ø3.5	

Type	One-touch fitting model	B ^{Note)}	C ^{Note)}
Metric size one-touch fitting	KQ2H06-02AS	12	153.2
	KQ2H08-02AS	17.3	158.6
	KQ2H10-02AS	22.6	163.8
Inch size one-touch fitting	KQ2H07-35AS	12.3	153.2
	KQ2H09-35AS	17.7	158.9
	KQ2H11-35AS	20.7	162

Note) Reference dimensions after installation

Dimensions: Nozzles/Series KN

Nozzle with self-align fitting/KN

(mm)

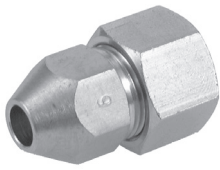

Model	Nozzle size øD	Applicable tubing O.D.	Width across flats		L ₁	M	Weight (g)
			H ₁	H ₂			
KN-04-100	ø1	ø4	10	10	27	15	13
KN-04-150	ø1.5	ø4	10	10	27.7	15	14
KN-06-100	ø1	ø6	12	12	30.1	16	19
KN-06-150	ø1.5	ø6	12	12	30.8	16	20
KN-06-200	ø2	ø6	12	12	31.5	16	22
KN-08-150	ø1.5	ø8	14	14	33.8	16	28
KN-08-200	ø2	ø8	14	14	34.6	16	30
KN-10-250	ø2.5	ø10	14	17	35.6	17	35
KN-10-300	ø3	ø10	14	17	36.3	17	36
KN-10-350	ø3.5	ø10	14	17	37.1	17	37
KN-10-400	ø4	ø10	14	17	29.5	17	30
KN-10-600	ø6	ø10	14	17	27.7	17	28
KN-12-350	ø3.5	ø12	17	19	40.4	17	54
KN-12-400	ø4	ø12	17	19	41.3	17	55
KN-12-600	ø6	ø12	17	19	31.2	17	40
KN-16-400	ø4	ø16	22	24	40.1	17	77
KN-16-600	ø6	ø16	22	24	38.4	17	79
KN-20-400	ø4	ø20	26	27	45.6	17	117
KN-20-600	ø6	ø20	26	27	43.9	17	112

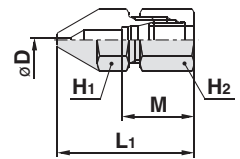

Male thread nozzle: V

[mm]



Model	Nozzle size øD	Connection thread	Width across flats	L ₁	A*	Weight (g)
			H ₁			
KN-R01-100	ø1	R 1/8	10	21.4	17.4	8
KN-R01-150	ø1.5	R 1/8	10	21	17	8
KN-R02-100	ø1	R 1/4	14	31.4	25.4	19
KN-R02-150	ø1.5	R 1/4	14	31	25	20
KN-R02-200	ø2	R 1/4	14	30.5	24.5	21
KN-R02-250	ø2.5	R 1/4	14	30.1	24.1	21
KN-R02-600	ø6	R 1/4	14	27.1	21.1	22
KN-R03-400	ø4	R 3/8	17	31.8	25.4	36
KN-R03-600	ø6	R 3/8	17	30.1	23.7	37
KN-R04-400	ø4	R 1/2	22	41.8	33.6	75
KN-R04-600	ø6	R 1/2	22	40.1	31.8	76
KN-R06-600	ø6	R 3/4	27	49.6	40.1	149
KN-R06-800	ø8	R 3/4	27	47.8	38	152
KN-R10-800	ø8	R 1	36	62.8	52.4	328
VMG1-R02-300	ø3	R 1/4	14	30	24	
VMG1-R02-350	ø3.5	R 1/4	14	29.5	23.5	
VMG1-R02-400	ø4	R 1/4	14	29.5	23.5	

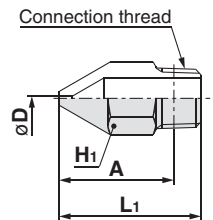

* Reference dimensions after R thread installation.

Copper extension nozzle/KNL

(mm)



Model	Nozzle size øD	Outside diameter	L ₁	Weight (g)
KNL3-06-150	ø1.5	ø6	300	43
KNL3-06-200	ø2	ø6	300	43
KNL3-08-200	ø2	ø8	300	61
KNL3-08-250	ø2.5	ø8	300	61
KNL3-10-250	ø2.5	ø10	300	94
KNL3-10-300	ø3	ø10	300	94
KNL6-06-150	ø1.5	ø6	600	84
KNL6-06-200	ø2	ø6	600	84
KNL6-08-200	ø2	ø8	600	117
KNL6-08-250	ø2.5	ø8	600	117
KNL6-10-250	ø2.5	ø10	600	183
KNL6-10-300	ø3	ø10	600	183

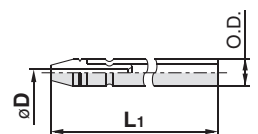

Nozzle for One-touch fitting (Resin type)/KN-Q□A

(mm)



Model	Nozzle dia. øD	Applicable fitting size ød	L ₁	A* ¹	Weight [g]
KN-Q06A-100	ø1	ø6	35	21.8	1
KN-Q06A-150	ø1.5	ø6	35	21.8	1
KN-Q06A-200	ø2	ø6	35	21.8	1
KN-Q08A-150	ø1.5	ø8	39	24.8	2
KN-Q08A-200	ø2	ø8	39	24.8	2
KN-Q10A-200	ø2	ø10	43	27.4	3
KN-Q10A-250	ø2.5	ø10	43	27.4	3
KN-Q12A-250	ø2.5	ø12	45.5	28.5	4
KN-Q12A-300	ø3	ø12	45.5	28.5	4

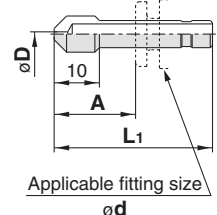

*1 Dimensions shown are for nozzle connected to the KQ2 series.

⚠ Warning [Mounting / Piping] Applicable nozzle: Nozzle for One-touch fitting (Resin/Metal type)

When connecting the nozzle to the One-touch fitting, insert it securely until it cannot move any further. After setting the nozzle deep into the fitting, be sure to pull on the nozzle to confirm that it is firm and does not budge. If the nozzle is not secured all the way at the back of the fitting or if there is insufficient engagement with the One-touch fitting, the nozzle may dislodge during pressurization, which is dangerous and may result in injury or accident.

Nozzle for One-touch fitting/KN

(mm)



Connecting products with metal rods
Products with metal rods cannot be connected to the KQ2 series One-touch fittings. If connected, the metal rod cannot be retained by the chuck of the One-touch fitting and products with metal rods may project during pressurization, causing serious personal injury or accident. For details about One-touch fittings that can connect products with metal rods, contact SMC.

Model	Nozzle size øD	Applicable fitting size ød	L ₁	A	Weight (g)
KN-Q06-100	ø1	ø6	35	18	5
KN-Q06-150	ø1.5	ø6	35	18	5
KN-Q06-200	ø2	ø6	35	18	5
KN-Q08-150	ø1.5	ø8	39	20.5	9
KN-Q08-200	ø2	ø8	39	20.5	9
KN-Q10-200	ø2	ø10	43	22	16
KN-Q10-250	ø2.5	ø10	43	22	16
KN-Q12-250	ø2.5	ø12	45.5	24	23
KN-Q12-300	ø3	ø12	45.5	24	23

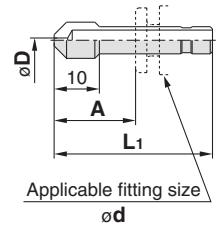

Pivoting nozzle with self-align fitting/KNK

(mm)

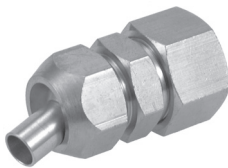

Model	Nozzle size øD	Applicable tubing O.D.	Width across flats		L ₁	M	Weight (g)
			H ₁	H ₂			
KNK-10-400	ø4	ø10	17	17	41.7	17	44
KNK-10-600	ø6	ø10	17	17	41.7	17	44
KNK-12-400	ø4	ø12	17	19	41.2	17	44
KNK-12-600	ø6	ø12	17	19	41.2	17	44
KNK-16-400	ø4	ø16	17	24	41.8	17	64
KNK-16-600	ø6	ø16	17	24	41.8	17	64
KNK-20-400	ø4	ø20	17	27	43.8	17	77
KNK-20-600	ø6	ø20	17	27	43.8	17	77

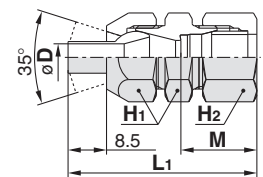

Pivoting nozzle with male thread/KNK

(mm)



Model	Nozzle size øD	Connection thread	Width across flats		L ₁	A*	Weight (g)
			H ₁	H ₂			
KNK-R02-400	ø4	R 1/4	17	17	38	31.9	32
KNK-R02-600	ø6	R 1/4	17	17	38	31.9	32
KNK-R03-400	ø4	R 3/8	17	17	39	32.4	40
KNK-R03-600	ø6	R 3/8	17	17	39	32.4	40
KNK-R04-400	ø4	R 1/2	17	22	42.2	34.1	54
KNK-R04-600	ø6	R 1/2	17	22	42.2	34.1	54

* Reference dimensions after R thread installation.

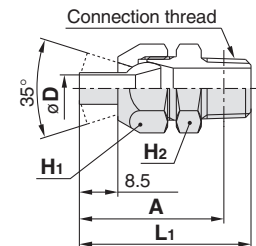

High efficiency nozzle/KNH

(mm)



Model	Nozzle size øD	Connection thread	Width across flats	L ₁	A*	Weight (g)
			H ₁			
KNH-R02-100	ø1	R 1/4	14	52	46	38
KNH-R02-150	ø1.5	R 1/4	14	52	46	38
KNH-R02-200	ø2	R 1/4	14	52	46	38

* Reference dimensions after R thread installation.

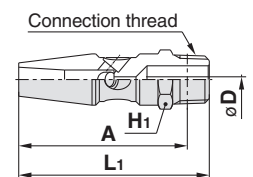

Low noise nozzle with self-align fitting/KNS

(mm)

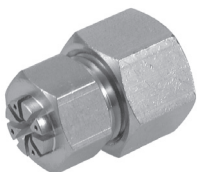

Model	Nozzle size øD	Applicable tubing O.D.	Width across flats		L ₁	M	Weight (g)
			H ₁	H ₂			
KNS-08-075-4	ø0.75 x 4	ø8	12	14	24.3	16	17
KNS-08-100-4	ø1 x 4	ø8	12	14	24.3	16	17
KNS-10-075-4	ø0.75 x 4	ø10	14	17	24	17	24
KNS-10-090-8	ø0.9 x 8	ø10	14	17	24	17	24
KNS-10-100-4	ø1 x 4	ø10	14	17	24	17	24

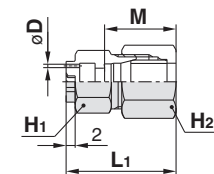

Low noise nozzle with male thread/KNS

(mm)



Model	Nozzle size øD	Connection thread	Width across flats	L ₁	A*	Weight (g)
			H ₁			
KNS-R01-075-4	ø0.75 x 4	R 1/8	12	18	14	9
KNS-R01-100-4	ø1 x 4	R 1/8	12	18	14	9
KNS-R01-090-8	ø0.9 x 8	R 1/8	12	18	14	9
KNS-R02-075-4	ø0.75 x 4	R 1/4	14	20	14	13
KNS-R02-090-8	ø0.9 x 8	R 1/4	14	20	14	13
KNS-R02-100-4	ø1 x 4	R 1/4	14	20	14	13
KNS-R02-110-8	ø1.1 x 8	R 1/4	14	20	14	13

* Reference dimensions after R thread installation.

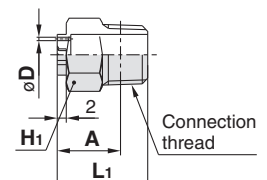

Sensing Heads

Standard sensing head/KNP



Model	Nozzle size øD	Applicable tubing O.D.	Width across flats		M	L ₁	L ₂	Weight (g)
			H ₁	H ₂				
KNP-1	ø2.5	ø4	5	8	13.3	64.6	986.7	7

* A 1 m polyurethane tube is included.

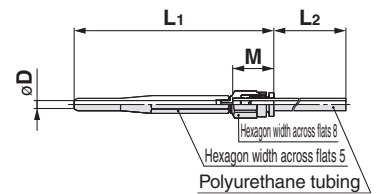

Needle sensing head/KNP



Model	Nozzle size øD	Applicable tubing O.D.	Cassette size H ₁	M	L ₁	L ₂	L ₃	Weight (g)

* A 1 m polyurethane tube is included.

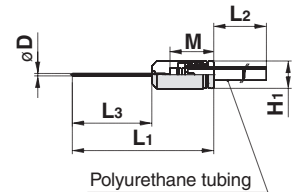

Use to measure workpiece collision pressure.

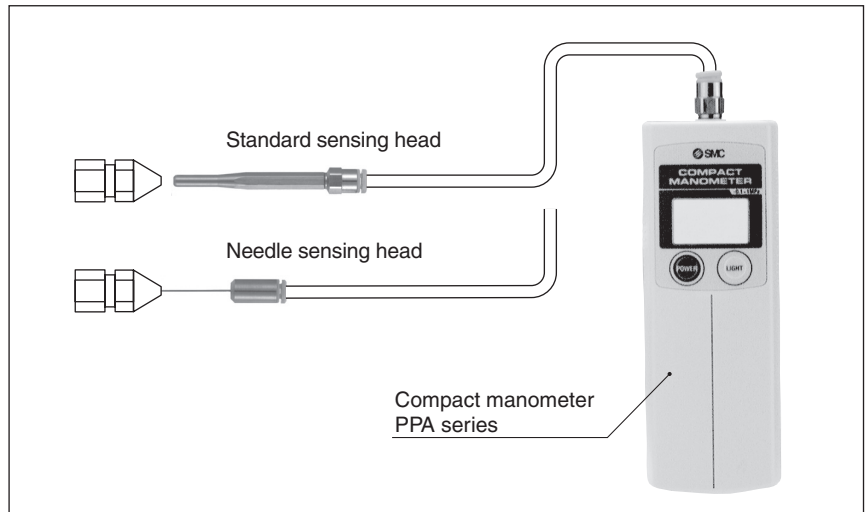

Principal Parts Material

KN, KNK, KNH, KNS

Body, nut	C3604
Sleeve (Self-align fitting type)	C2700
Nozzle (Pivoting type)	Stainless steel 303

KNL

Pipe	C1220T-0
Nozzle	C3604

KNP-1

Pressure spindle	Stainless steel 303
One-touch fittings	POM, NBR, Stainless steel 303, Stainless steel 304
Polyurethane tube (ø4, 1 m)	Polyurethane

KNP-2

Pipe	Stainless steel 304
One-touch fittings	POM, NBR, Stainless steel 304
Polyurethane tube (ø4, 1 m)	Polyurethane

Specifications

Nozzle (KN, KNK, KNH, KNS, KNL)

Applicable tubing material	Nylon, Soft nylon, Flexible copper pipe (C1220T-O), OST pipe	
Applicable tubing O.D.	ø4, ø6, ø8, ø10, ø12, ø16, ø20	
Fluid	Air, Coolant	
Maximum operating pressure	1 MPa (0.3 MPa with OST pipe)	
Ambient and fluid temperature	-5 to 60°C (No freezing)	
Threads	Mounting	JISB0203 (taper threads for piping)
	Nut	JISB0205 (Metric fine thread)
Seal on the threads	None	
Copper-free (Standard)	Brass parts are all electroless nickel plated.	

Sensing head (KNP)

Applicable tubing O.D.	ø4
Fluid	Air
Maximum operating pressure (at 20°C)	0.8 MPa
Ambient and fluid temperature	-5 to 60°C (No freezing)

Series VMG

Copper extension nozzle set

[mm]



Part no.	Nozzle size D	Outside diameter	L ₁	L ₂ ^{Note 1)}	L ^{Note 1)}	Width across flats H ₁
VMG1-06-150-100	ø1.5	ø6	100	100	106	12
VMG1-06-200-100	ø2					
VMG1-06-150-150	ø1.5					
VMG1-06-200-150	ø2					
VMG1-06-150-300	ø1.5					
VMG1-06-200-300	ø2					
VMG1-06-150-600	ø1.5	ø8	600	600	606	14
VMG1-06-200-600	ø2					
VMG1-08-250-100	ø2.5					
VMG1-08-300-100	ø3					
VMG1-08-350-100	ø3.5					
VMG1-08-250-150	ø2.5					
VMG1-08-300-150	ø3					
VMG1-08-350-150	ø3.5					
VMG1-08-250-300	ø2.5	ø8	300	300	306	14
VMG1-08-300-300	ø3					
VMG1-08-350-300	ø3.5					
VMG1-08-250-600	ø2.5					
VMG1-08-300-600	ø3					
VMG1-08-350-600	ø3.5					

Note 1) Reference dimensions after installation

Note 2) Copper extension nozzle and self-align fitting are included in the same package, (but unassembled). Refer to "How to attach extension nozzle" in the operation manual for assembly procedures.

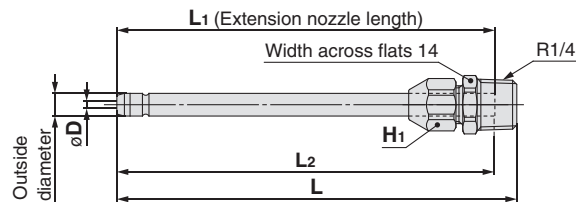

Dimension: Nozzle Cover

Cover for male thread nozzle

[mm]

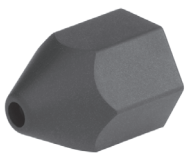

Nozzle cover part no.	Material	Applicable blow gun model	
		Model	Nozzle type
P5670129-01	HNBR	VMG1□□-□-01 to 04	Male thread nozzle ø1 to ø2.5
P5670129-01F	Fluororubber		Male thread nozzle ø3 to ø4
P5670129-02	HNBR	VMG1□□-□-05 to 07	Male thread nozzle ø3 to ø4
P5670129-02F	Fluororubber		

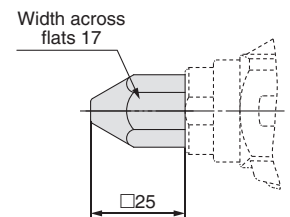

VMG1□-□□-1 to 04

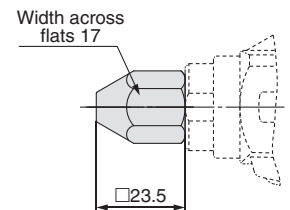

VMG1□-□□-05 to 07

Cover for copper extension nozzle

[mm]



Nozzle cover part no.	Material	Applicable blow gun model	
		Model	Nozzle type
P5670129-11	HNBR	VMG1□□-□-31 to 38	ø6 copper extension nozzle
P5670129-11F	Fluororubber		

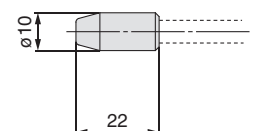

VMG1□-□□-31 to 38



Series VMG

Specific Product Precautions 1

Be sure to read this before handling.

Selection

⚠ Warning

1. Check the specifications.

The products in this catalogue are designed to be used in compressed air systems only. If the products are used in an environment where pressure or temperature is out of the specified range, damage and/or malfunction may result. Do not use under such conditions.

⚠ Caution

1. Do not apply the blow gun to flammable, explosive or toxic substances such as gas, fuel gas or refrigerant. Such substances may exude from inside the blow gun.

Mounting

⚠ Warning

1. Install a stop valve on the supply pressure side of the blow gun to enable emergency shut off in case of unexpected leakage or damage.
2. When installing a nozzle on the blow gun, wrap pipe tape around the threads of the nozzle.
3. When installing the nozzle, secure the nozzle holder of the blow gun by applying a wrench of 22 mm width across flats to the two chamfered surfaces of the holder without applying force to the body. Then, tighten the nozzle with force within the torque range below. As a guideline, it is equivalent to 2 to 3 additional turns with a tool after manual tightening.

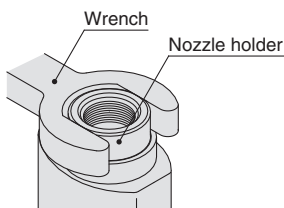

Nozzle tightening torque range	12 to 14 N·m
--------------------------------	--------------

Insufficient tightening may cause loosening of the nozzle.

Piping

⚠ Caution

1. Check the model, type and size before installation.
Also, confirm that there is no scratches, gouges or cracks on the product.
2. Before piping
Before piping, it should be thoroughly blown out with air (flushing) or washed to remove chips, cutting oil and other debris from inside the pipe.

Piping

⚠ Caution

3. Wrapping of pipe tape

When screwing together pipes and fittings, etc., be certain that chips from the pipe threads and sealing material do not get inside the blow gun. Also, when the pipe tape is used, leave 1.5 to 2 thread ridges exposed at the end of the threads.

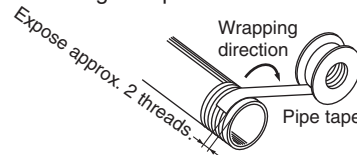

4. When tightening the threads, secure the nozzle holder of the blow gun by applying a wrench of 22 mm width across flats to the two chamfered surfaces of the holder without applying force to the body. Then, tighten the nozzle with torque specified in the table below. As a guideline, it is equivalent to 2 to 3 additional turns with a tool after manual tightening.

Be careful that tightening with torque beyond the ranges in the table below may cause damage to the body.

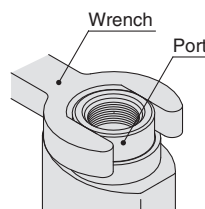

Male thread	Tightening torque N·m
R1/4	12 to 14
R3/8	22 to 24

5. Allow extra length when connecting a tube to accommodate changes in tube length due to pressure.
6. Confirm that no twisting, turning or tensile force or moment load is applied to the port or tube. This may cause fittings to fracture or tubes to be crushed, burst or come loose.
7. Do not abrade, entangle or scratch the tube. This may cause the tube to be crushed, burst or come loose.

Lubrication

⚠ Warning

1. Do not lubricate the product.
It may contaminate or damage the target object.

Air Supply

⚠ Warning

1. Use clean air.
Do not use compressed air which includes chemicals, synthetic oils containing organic solvents, salt or corrosive gases, etc., as it can cause damage or malfunction.



Series VMG

Specific Product Precautions 2

Be sure to read this before handling.

Air Supply

⚠ Caution

1. Install air filters.

Install air filters at the upstream side of blow gun. Choose the filtration degree of 5 μm or finer.

2. Install an after-cooler, air dryer or water droplet separator, etc.

Air excessive drainage may cause a malfunction of blow gun and contaminate or damage the target object. To prevent this, install an after-cooler, air dryer or water droplet separator, etc.

Operating Environment

⚠ Warning

1. Do not use in an atmosphere of corrosive gases, chemicals, sea water, water or water vapor or in an environment where such substances may adhere.

2. Provide shading in an environment where the product is exposed to the sunlight.

3. Do not use in an environment where a heat source is at a close distance.

4. Do not use in an environment where static electricity is a problem. It may cause malfunction or failure of the system. Please contact SMC for use in such an environment.

5. Do not use in an environment where spatters are generated. There is danger of fires caused by spattering. Please contact SMC for use in such an environment.

6. Do not use in an environment where the product is exposed to cutting oil, lubricating oil or coolant oil. Please contact SMC for use in an environment where the product is exposed to such liquid as cutting oil, lubricating oil or coolant oil.

Maintenance

⚠ Caution

1. In periodical inspections, check the following items and replace the parts if necessary.

- Scratches, gouges, abrasion, corrosion
- Air leakage
- Twisting, crushing and turning of connected tubes
- Hardening, deterioration and softening of connected tubes
- Loosening of nozzles

2. When removing the product, first stop the pressure supply, exhaust compressed air in the piping and check the condition of atmospheric release.

3. Do not disassemble or remodel the body of the product.

Handling

⚠ Warning

1. To prevent lurching of the nozzle due to air pressure, confirm that the nozzle is not loosened or rattling by pulling it by hand before operation.

2. Make sure to wear safety goggles to protect yourself from splashed substances.

3. Do not direct the tip of the nozzle at the face or other parts of a human body. It may cause danger to personnel.

4. Do not use the product to clean or remove toxic substances or chemicals.

5. Do not drop, step on or hit the product. It may cause damage to the product.

6. Do not use the product to disturb public order or public hygiene.

7. This product is not a toy.

8. After blowing, make sure to hang the product on a hook, etc.

If leaving the product in a dusty place, particles will enter the product and may result in a malfunction.

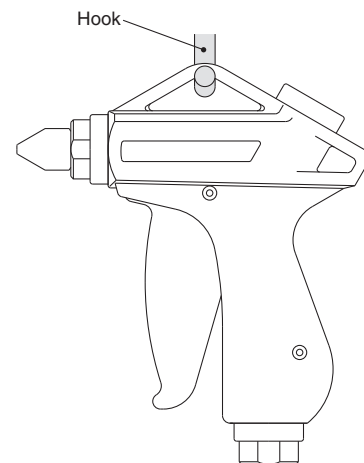



9. When the blow gun is used or stored, confirm that no twisting, turning or tensile force or moment load is applied to the port or tube. This may cause fittings to fracture or tubes to be crushed, burst or come loose.

10. When attaching a nozzle cover, align the hex parts of the nozzle and nozzle cover before covering. When attaching an extension nozzle cover, confirm that the nozzle tip is completely inserted into the extension nozzle cover.

11. Do not use a nozzle cover or extension nozzle cover if it is cracked or does not fit securely, and replace with a new cover.

Safety Instructions

These safety instructions are intended to prevent hazardous situations and/or equipment damage. These instructions indicate the level of potential hazard with the labels of “Caution,” “Warning” or “Danger.” They are all important notes for safety and must be followed in addition to International Standards (ISO/IEC) ¹⁾, and other safety regulations.

-  **Caution:** **Caution** indicates a hazard with a low level of risk which, if not avoided, could result in minor or moderate injury.
-  **Warning:** **Warning** indicates a hazard with a medium level of risk which, if not avoided, could result in death or serious injury.
-  **Danger:** **Danger** indicates a hazard with a high level of risk which, if not avoided, will result in death or serious injury.

- 1) ISO 4414: Pneumatic fluid power – General rules relating to systems.
ISO 4413: Hydraulic fluid power – General rules relating to systems.
IEC 60204-1: Safety of machinery – Electrical equipment of machines.
(Part 1: General requirements)
ISO 10218-1: Manipulating industrial robots - Safety.
etc.

Warning

1. The compatibility of the product is the responsibility of the person who designs the equipment or decides its specifications.

Since the product specified here is used under various operating conditions, its compatibility with specific equipment must be decided by the person who designs the equipment or decides its specifications based on necessary analysis and test results. The expected performance and safety assurance of the equipment will be the responsibility of the person who has determined its compatibility with the product. This person should also continuously review all specifications of the product referring to its latest catalogue information, with a view to giving due consideration to any possibility of equipment failure when configuring the equipment.

2. Only personnel with appropriate training should operate machinery and equipment.

The product specified here may become unsafe if handled incorrectly. The assembly, operation and maintenance of machines or equipment including our products must be performed by an operator who is appropriately trained and experienced.

3. Do not service or attempt to remove product and machinery/equipment until safety is confirmed.

1. The inspection and maintenance of machinery/equipment should only be performed after measures to prevent falling or runaway of the driven objects have been confirmed.
2. When the product is to be removed, confirm that the safety measures as mentioned above are implemented and the power from any appropriate source is cut, and read and understand the specific product precautions of all relevant products carefully.
3. Before machinery/equipment is restarted, take measures to prevent unexpected operation and malfunction.

4. Contact SMC beforehand and take special consideration of safety measures if the product is to be used in any of the following conditions.

1. Conditions and environments outside of the given specifications, or use outdoors or in a place exposed to direct sunlight.
2. Installation on equipment in conjunction with atomic energy, railways, air navigation, space, shipping, vehicles, military, medical treatment, combustion and recreation, or equipment in contact with food and beverages, emergency stop circuits, clutch and brake circuits in press applications, safety equipment or other applications unsuitable for the standard specifications described in the product catalogue.
3. An application which could have negative effects on people, property, or animals requiring special safety analysis.
4. Use in an interlock circuit, which requires the provision of double interlock for possible failure by using a mechanical protective function, and periodical checks to confirm proper operation.

Caution

1. The product is provided for use in manufacturing industries.

The product herein described is basically provided for peaceful use in manufacturing industries. If considering using the product in other industries, consult SMC beforehand and exchange specifications or a contract if necessary. If anything is unclear, contact your nearest sales branch.

Limited warranty and Disclaimer/Compliance Requirements

The product used is subject to the following “Limited warranty and Disclaimer” and “Compliance Requirements”. Read and accept them before using the product.

Limited warranty and Disclaimer

1. The warranty period of the product is 1 year in service or 1.5 years after the product is delivered, whichever is first. ²⁾ Also, the product may have specified durability, running distance or replacement parts. Please consult your nearest sales branch.
 2. For any failure or damage reported within the warranty period which is clearly our responsibility, a replacement product or necessary parts will be provided. This limited warranty applies only to our product independently, and not to any other damage incurred due to the failure of the product.
 3. Prior to using SMC products, please read and understand the warranty terms and disclaimers noted in the specified catalogue for the particular products.
- 2) Vacuum pads are excluded from this 1 year warranty.
A vacuum pad is a consumable part, so it is warranted for a year after it is delivered. Also, even within the warranty period, the wear of a product due to the use of the vacuum pad or failure due to the deterioration of rubber material are not covered by the limited warranty.

Compliance Requirements

1. The use of SMC products with production equipment for the manufacture of weapons of mass destruction (WMD) or any other weapon is strictly prohibited.
2. The exports of SMC products or technology from one country to another are governed by the relevant security laws and regulations of the countries involved in the transaction. Prior to the shipment of a SMC product to another country, assure that all local rules governing that export are known and followed.

Caution

SMC products are not intended for use as instruments for legal metrology.

Measurement instruments that SMC manufactures or sells have not been qualified by type approval tests relevant to the metrology (measurement) laws of each country. Therefore, SMC products cannot be used for business or certification ordained by the metrology (measurement) laws of each country.

Safety Instructions

Be sure to read “Handling Precautions for SMC Products” (M-E03-3) before using.

SMC Corporation (Europe)

Austria	+43 (0)2262622800	www.smc.at	office@smc.at
Belgium	+32 (0)33551464	www.smc.be	info@smc.be
Bulgaria	+359 (0)2807670	www.smc.bg	office@smc.bg
Croatia	+385 (0)13707288	www.smc.hr	office@smc.hr
Czech Republic	+420 541424611	www.smc.cz	office@smc.cz
Denmark	+45 70252900	www.smc.dk.com	smc@smcdk.com
Estonia	+372 651 0370	www.smcee.ee	info@smcee.ee
Finland	+358 207513513	www.smc.fi	smcfi@smc.fi
France	+33 (0)164761000	www.smc-france.fr	supportclient@smc-france.fr
Germany	+49 (0)61034020	www.smc.de	info@smc.de
Greece	+30 210 2717265	www.smchellas.gr	sales@smchellas.gr
Hungary	+36 23513000	www.smc.hu	office@smc.hu
Ireland	+353 (0)14039000	www.smcautomation.ie	sales@smcautomation.ie
Italy	+39 03990691	www.smcitalia.it	mailbox@smcitalia.it
Latvia	+371 67817700	www.smc.lv	info@smc.lv

Lithuania	+370 5 2308118	www.smclt.lt	info@smclt.lt
Netherlands	+31 (0)205318888	www.smc.nl	info@smc.nl
Norway	+47 67129020	www.smc-norge.no	post@smc-norge.no
Poland	+48 222119600	www.smc.pl	office@smc.pl
Portugal	+351 214724500	www.smc.eu	apoioclientept@smc.smces.es
Romania	+40 213205111	www.smcromania.ro	smcromania@smcromania.ro
Russia	+7 (812)3036600	www.smc.eu	sales@smcru.com
Slovakia	+421 (0)413213212	www.smc.sk	office@smc.sk
Slovenia	+386 (0)73885412	www.smc.si	office@smc.si
Spain	+34 945184100	www.smc.eu	post@smc.smces.es
Sweden	+46 (0)86031240	www.smc.nu	smc@smc.nu
Switzerland	+41 (0)523963131	www.smc.ch	info@smc.ch
Turkey	+90 212 489 0 440	www.smcturkey.com.tr	satis@smcturkey.com.tr
UK	+44 (0)845 121 5122	www.smc.uk	sales@smc.uk

South Africa +27 10 900 1233 www.smcza.co.za zasales@smcza.co.za